



AS Level Physics

Chapter 3 – Electric Circuits

3.5.2 Series and Parallel Circuit

Worked Examples

Series and Parallel Circuit

Exam Style Question 1

The circuit diagram shows a 12 V d.c. supply of negligible internal resistance connected to an arrangement of resistors. The current at three places in the circuit and the resistance of two of the resistors are given on the diagram.

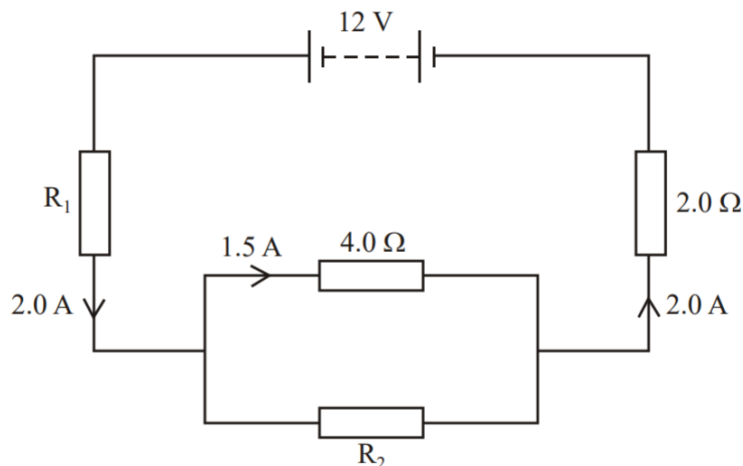

- Calculate the potential difference across the 4.0 Ω resistor
- Calculate the resistance of resistor R_2 .
- Calculate the resistance of resistor R_1 .

Series and Parallel Circuit

Exam Style Question 1

(a) Calculate the potential difference across the 4.0 Ω resistor.

1.5 A goes into the resistor so use $V = IR$

$$V = 1.5 A \times 4 \Omega$$

$$V = 6 V$$

(b) Calculate the resistance of resistor R_2 .

Current through $R_2 = 0.5 A$ (Kirchhoff's first law)

As R_2 is parallel to the 4 Ω , R_2 also has 6 V.

So use $V = IR$ and rearrange for R :

$$R_2 = \frac{V}{I} = \frac{6 V}{0.5 A} = 12 \Omega$$

(c) Calculate the resistance of resistor R_1 .

Step 1: Calculate the voltage through the 2.0 Ω resistor:

$$V = IR = 2.0 A \times 2.0 \Omega = 4 V$$

Step 2: Find out the voltage through R_1 (using Kirchhoff's second law):

$$p.d. \text{ across } R_1 = 12 V - 6 V - 4 V = 2 V$$

Current through R_1 is 2.0 A.

Step 3: Use $V = IR$ and rearrange it for R_1 :

$$R_1 = \frac{V}{I} = \frac{2 V}{2 A} = 1 \Omega$$

Remember the R_2 and 4.0 Ω resistors are in parallel so they both share the same p.d. so you only need to include the 6 V value once.



Series and Parallel Circuit

Exam Style Question 2

- (a) Fig. 2.1 shows combinations of resistors connected to a power supply of e.m.f. E .

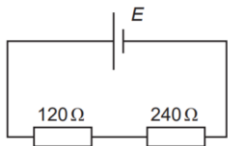

Fig. 2.1a

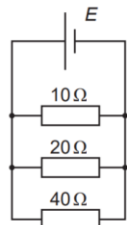

Fig. 2.1b

- (i) For the circuit of Fig. 2.1a

- 1) Calculate the total resistance R_s .
- 2) State one electrical quantity which is the same for both resistors.

- (ii) For the circuit of Fig. 2.1b

- 1) Calculate the total resistance R_p .
- 2) State one electrical quantity which is the same for all the resistors.

- (b) Fig. 2.2 shows the I – V characteristics of two electrical components, a resistor, line R and a thermistor, line T .

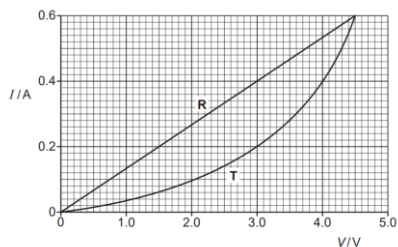

Fig. 2.2

tutorpacks.co.uk

Series and Parallel Circuit

Exam Style Question 2

- (i) State Ohm's law. Use Fig. 2.2 to explain why component R obeys Ohm's law.
- (ii) The resistor and the thermistor can be connected to a variable voltage supply of negligible internal resistance in two ways as shown in Fig. 2.3a and Fig. 2.3b.

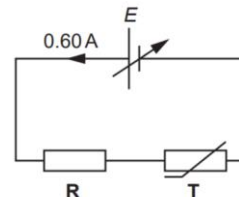

Fig. 2.3a

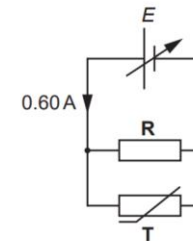

Fig. 2.3b

The voltage of the supply is varied in each circuit until the current drawn from it is 0.60 A . Use data from Fig. 2.2 to explain why the e.m.f. E of the supply is

- 1) 9.0 V in Fig. 2.3a
- 2) 3.0 V in Fig. 2.3b

- (iii) The thermistor is now connected on its own across the terminals of the supply set at 4.5 V . Fig. 2.4 shows the variation of current I with time t from the moment the thermistor is connected to the supply.

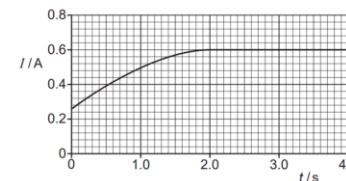

Fig. 2.4

Explain the shape of the graph in Fig. 2.4.

tutorpacks.co.uk



Series and Parallel Circuit

Exam Style Question 2

(a) (i) (1) For the circuit of Fig. 2.1a calculate the total resistance R_S .
For resistors in series:

$$R_{total} = R_1 + R_2 + R_3 \dots \dots + R_N$$
$$R_S = 120 \Omega + 240 \Omega$$
$$R_S = 360 \Omega$$

(a) (i) (2) For the circuit of Fig. 2.1a state one electrical quantity which is the same for both resistors.

Current

(a) (ii) (1) For the circuit of Fig. 2.1b calculate the total resistance R_p .
For resistors in parallel:

$$\frac{1}{R_{TOTAL}} = \frac{1}{R_1} + \frac{1}{R_2} + \frac{1}{R_3} \dots \dots + \frac{1}{R_N}$$
$$\frac{1}{R_p} = \frac{1}{10 \Omega} + \frac{1}{20 \Omega} + \frac{1}{40 \Omega}$$
$$\frac{1}{R_p} = \frac{7}{40}$$
$$R_p = \frac{40}{7} = 5.714285714 \Omega$$
$$R_p = 5.7 \Omega$$

(a) (ii) (2) For the circuit of Fig. 2.1b state one electrical quantity which is the same for all the resistors.

Potential difference.

(b) (i) State Ohm's law. Use Fig. 2.2 to explain why component R obeys Ohm's law.

Current through a conductor between two points is directly proportional to the potential difference as long as temperature and /or other physical conditions remain constant.

R line is straight and through the origin therefore it obeys Ohm's law.

Series and Parallel Circuit

Exam Style Question 2

(b) (ii) (1) Use data from Fig. 2.2 to explain why the e.m.f. E of the supply is 9.0 V in Fig. 2.3a.

As the current drawn from the supply is 0.60 A and is the same current for both the resistor and thermistor we can see from the graph that the voltage for both the resistor (R) and thermistor (T) is 4.5 V .
Therefore total voltage of the supply is:

$$E = 4.5 \text{ V} + 4.5 \text{ V} = 9.0 \text{ V}$$

(b) (ii) (2) Use data from Fig. 2.2 to explain why the e.m.f. E of the supply is 3.0 V in Fig. 2.3b.

At 3.0 V the current through the resistor (R) is 0.4 A and the thermistor T is 0.2 A . We can add the current to give:

$$0.4 \text{ A} + 0.2 \text{ A} = 0.60 \text{ A}$$

So we know that the current is drawn at 0.60 A therefore the voltage of the supply is 3.0 V .

(iii) Explain the shape of the graph in Fig. 2.4.

Thermistor heats up and temperature increases. This causes the resistance of the thermistor to decrease so current rises. After 2s the temperature becomes constant because thermal equilibrium is reached so the energy generated = energy lost.



Series and Parallel Circuit

Exam Style Question 3

- (a) In the circuit in Figure 1, the battery, of emf 15 V and the negligible internal resistance, is connected in series with two lamps and a resistor. The three components each have a resistance of $12\ \Omega$.

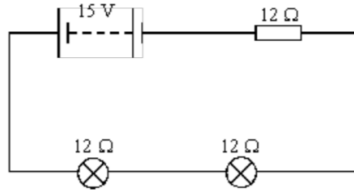

Figure 1

- (i) What is the voltage across each lamp?
 (ii) Calculate the current through the lamps.
- (b) The two lamps are now disconnected and reconnected in parallel as shown in Figure 2.

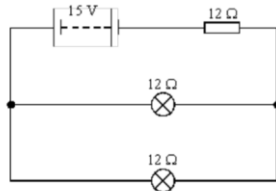

Figure 2

- (i) Show that the current supplied by the battery is 0.83 A .
 (ii) Hence show that the current in each lamp is the same as the current in the lamps in the circuit in Figure 1.
- (c) How does the brightness of the lamps in the circuit in Figure 1 compare with the brightness of the lamps in the circuit in Figure 2?
 Explain your answer.

Series and Parallel Circuit

Exam Style Question 3

- (a) (i) What is the voltage across each lamp?

There are three components in this circuit each with the same resistance so the voltage from the battery is shared evenly between the three components:

$$V_{lamp} = \frac{15\text{ V}}{3} = 5\text{ V}$$

- (a) (ii) Calculate the current through the lamps.

Because the components are in series the current will be the same for every component. So find the total resistance which is:

$$R_{total} = 12\ \Omega + 12\ \Omega + 12\ \Omega = 36\ \Omega$$

Then use $V = IR$ and rearrange for I :

$$I = \frac{V}{R} = \frac{15\text{ V}}{36\ \Omega} = 0.42\text{ A}$$

- (b) (i) Show that the current supplied by the battery is 0.83 A .

Step 1: First calculate the combined resistance of the lamps in parallel ($12\ \Omega$ & $12\ \Omega$):

$$\frac{1}{R_{total}} = \frac{1}{R_1} + \frac{1}{R_2} = \frac{1}{12} + \frac{1}{12} = \frac{1}{6}$$

$$\frac{1}{R_{total}} = \frac{1}{6}$$

$$R_{total} = \frac{1}{\left(\frac{1}{6}\right)} = 6\ \Omega$$

Step 2: Now that you have calculated the total resistance of the lamps in parallel you can re-draw the circuit to make it easier to visualise:

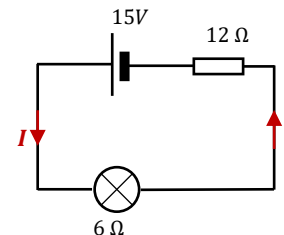

You can see the resistors and lamp are in series so you calculate the overall resistance using:

$$R_{total} = 6\ \Omega + 12\ \Omega$$

$$R_{total} = 18\ \Omega$$

Series and Parallel Circuit

Exam Style Question 3

- (a) In the circuit in Figure 1, the battery, of emf 15 V and the negligible internal resistance, is connected in series with two lamps and a resistor. The three components each have a resistance of $12\ \Omega$.

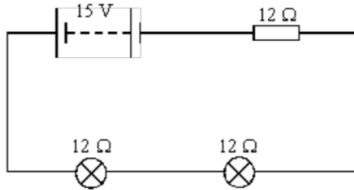

Figure 1

- (i) What is the voltage across each lamp?
(ii) Calculate the current through the lamps.
- (b) The two lamps are now disconnected and reconnected in parallel as shown in Figure 2.

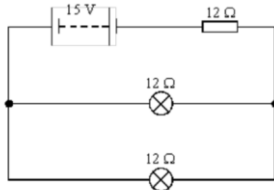

Figure 2

- (i) Show that the current supplied by the battery is 0.83 A .
(ii) Hence show that the current in each lamp is the same as the current in the lamps in the circuit in Figure 1.
- (c) How does the brightness of the lamps in the circuit in Figure 1 compare with the brightness of the lamps in the circuit in Figure 2?

Explain your answer.



Series and Parallel Circuit

Exam Style Question 3

- (b) (i) Show that the current supplied by the battery is 0.83 A .**

Step 3: Use $V = IR$ and rearrange for I :

$$I = \frac{V}{R} = \frac{15\text{ V}}{18\ \Omega} = 0.83333\text{ A}$$
$$I = 0.83\text{ A}$$

- (b) (ii) Hence show that the current in each lamp is the same as the current in the lamps in the circuit in Figure 1.**

Because the lamps are in parallel the current needs to split. As both lamps have the same resistance the current will divide equally between the lamps this means:

$$I = \frac{0.83\text{ A}}{2} = 0.415\text{ A}$$

Which is approx. 0.42 A and so the current in each lamp shown in Figure 2 is the same as the current in the lamps shown in Figure 1.

- (c) How does the brightness of the lamps in the circuit in Figure 1 compare with the brightness of the lamps in the circuit in Figure 2?**

Explain your answer.

They have the same brightness because they have the same current.

Series and Parallel Circuit

Exam Style Question 4

X and Y are two lamps. X is rated at $12\text{ V } 36\text{ W}$ and Y at $4.5\text{ V } 2.0\text{ W}$.

- (a) Calculate the current in each lamp when it is operated at its correct working voltage.
- (b) The two lamps are connected in the circuit shown in the figure below. The battery has an emf of 24 V and negligible internal resistance. The resistors, R_1 and R_2 are chosen so that the lamps are operating at their correct working voltage.

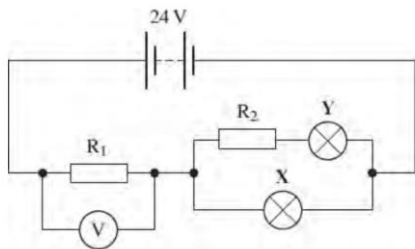

- (i) Calculate the p.d. across R_1 .
- (ii) Calculate the current in R_1 .
- (iii) Calculate the resistance of R_1 .
- (iv) Calculate the p.d. across R_2 .
- (v) Calculate the resistance of R_2 .
- (c) The filament of the lamp in X breaks and the lamp no longer conducts. It is observed that the voltmeter reading decreases and lamp Y glows more brightly.
- (i) Explain without calculation why the voltmeter reading decreases.
- (ii) Explain without calculation why the lamp Y glows more brightly.

Series and Parallel Circuit

Exam Style Question 4

- (a) Calculate the current in each lamp when it is operated at its correct working voltage.

Use $P = IV$ and rearrange for I .

$$\text{Lamp X: } I = \frac{P}{V} = \frac{36\text{ W}}{12\text{ V}} = 3.0\text{ A}$$

$$\text{Lamp Y: } I = \frac{P}{V} = \frac{2.0\text{ W}}{4.5\text{ V}} = 0.44\text{ A}$$

- (b) The two lamps are connected...

- (i) Calculate the p.d. across R_1 .

Remember resistors are chosen so that the lamps are operating at their correct working voltage. So resistor R_1 is ensuring lamp X is operating at 12 V . So R_1 needs to be rated at:

$$p.d. = 24\text{ V} - 12\text{ V} = 12\text{ V}$$

So resistor R_1 takes the 24 V from the battery and reduces it to 12 V .

- (ii) Calculate the current in R_1 .

We know the current coming from R_1 is split between lamp X and Lamp Y and re-joins together therefore current into R_1 must be:

$$I = 3.0\text{ A} + 0.44\text{ A} = 3.44\text{ A}$$

- (iii) Calculate the resistance of R_1 .

Use $V = IR$ and rearrange for R :

$$R = \frac{V}{I} = \frac{12\text{ V}}{3.44\text{ A}} = 3.5\ \Omega$$

- (iv) Calculate the p.d. across R_2 .

Remember the voltage coming out from R_1 is 12 V and Lamp Y needs to operate at 4.5 V . So R_2 needs to be rated at:

$$p.d. = 12\text{ V} - 4.5\text{ V} = 7.5\text{ V}$$

This will make sure only 4.5 V reaches Lamp Y.

- (v) Calculate the resistance of R_2 .

Use $V = IR$ and rearrange for R :

$$R = \frac{V}{I} = \frac{7.5\text{ V}}{0.44\text{ A}} = 17\ \Omega$$

Series and Parallel Circuit

Exam Style Question 4

X and Y are two lamps. X is rated at $12\text{ V } 36\text{ W}$ and Y at $4.5\text{ V } 2.0\text{ W}$.

- (a) Calculate the current in each lamp when it is operated at its correct working voltage.
- (b) The two lamps are connected in the circuit shown in the figure below. The battery has an emf of 24 V and negligible internal resistance. The resistors, R_1 and R_2 are chosen so that the lamps are operating at their correct working voltage.

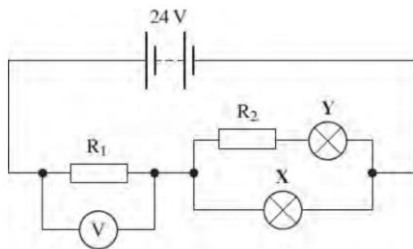

- (i) Calculate the p.d. across R_1 .
- (ii) Calculate the current in R_1 .
- (iii) Calculate the resistance of R_1 .
- (iv) Calculate the p.d. across R_2 .
- (v) Calculate the resistance of R_2 .
- (c) The filament of the lamp in X breaks and the lamp no longer conducts. It is observed that the voltmeter reading decreases and lamp Y glows more brightly.
- (i) Explain without calculation why the voltmeter reading decreases.
- (ii) Explain without calculation why the lamp Y glows more brightly.



Series and Parallel Circuit

Exam Style Question 4

(c) (i) Explain without calculation why the voltmeter reading decreases.

Circuit resistance increases and current is lower therefore reducing the voltage and the voltmeter reading.

(c) (ii) Explain without calculation why the lamp Y glows more brightly.

More current flows through Y and Y has a higher p.d. across it and hence the power is greater though Y (using $P = IV$).

Series and Parallel Circuit

Exam Style Question 5

The diagram below shows an arrangement of resistors.

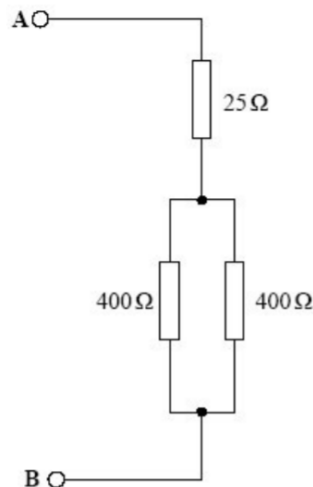

- (a) Calculate the total resistance between terminals *A* and *B*.
- (b) A potential difference is applied between the two terminals, *A* and *B*, and the power dissipated in each of the 400 Ω resistors is 1.0 W.
- (i) Calculate the potential difference across the 400 Ω resistors.
- (ii) Calculate the current through the 25 Ω resistor.
- (iii) Calculate the potential difference applied to terminate *A* and *B*.



Series and Parallel Circuit

Exam Style Question 5

(a) Calculate the total resistance between terminals *A* and *B*.

Step 1: First calculate the combined resistance of the resistors in parallel (400 Ω & 400 Ω):

$$\frac{1}{R_{total}} = \frac{1}{R_1} + \frac{1}{R_2} = \frac{1}{400 \Omega} + \frac{1}{400 \Omega}$$
$$\frac{1}{R_{total}} = \frac{1}{200}$$
$$R_{total} = \frac{1}{\left(\frac{1}{200}\right)} = 200 \Omega$$

Step 2: Now that you have calculated the total resistance of the resistors in parallel you can re-draw the circuit to make it easier to visualise:

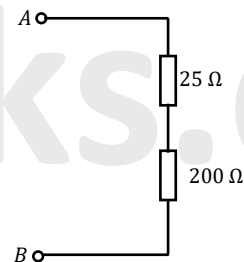

You can see the resistors are in series so calculate the overall resistance between *A* and *B* using:

$$R_{total} = 200 \Omega + 25 \Omega$$
$$R_{total} = 225 \Omega$$

(b) (i) Calculate the potential difference across the 400 Ω resistors.

Use $P = \frac{V^2}{R}$ and rearrange for *V*:

$$V^2 = P \times R = 1.0 W \times 400 \Omega$$
$$V^2 = 400$$
$$V = \sqrt{400} = 20 V$$

Series and Parallel Circuit

Exam Style Question 5

The diagram below shows an arrangement of resistors.

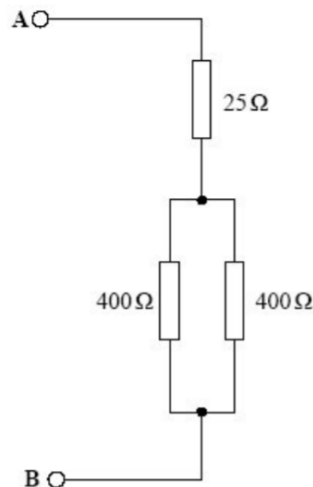

- Calculate the total resistance between terminals *A* and *B*.
- A potential difference is applied between the two terminals, *A* and *B*, and the power dissipated in each of the 400 Ω resistors is 1.0 W.
 - Calculate the potential difference across the 400 Ω resistors.
 - Calculate the current through the 25 Ω resistor.
 - Calculate the potential difference applied to terminate *A* and *B*.



Series and Parallel Circuit

Exam Style Question 5

(b) (ii) Calculate the current through the 25 Ω resistor.

We know that the voltage through one 400 Ω resistors is 20 V.

Therefore the current through it is:

$$I = \frac{V}{R} = \frac{20 \text{ V}}{400 \Omega} = 0.05 \text{ A}$$

But we have two resistors with the same resistance therefore the current through the second resistor is also 0.05 A.

Using Kirchoff's first law the current at the junction before the 25 Ω resistor is:

$$I = 0.05 \text{ A} + 0.05 \text{ A} = 0.10 \text{ A}$$

(b) (iii) Calculate the potential difference applied to terminate *A* and *B*.

Use $V = IR$ to calculate the p.d. across the 25 Ω resistor:

$$V = 0.10 \text{ A} \times 25 \Omega = 2.5 \text{ V}$$

Therefore the maximum applied p.d. = 20 V + 2.5 V = 22.5 V

Remember the p.d. across the 400 Ω resistors is 20 V and because they are parallel to each other they both have the same voltage so when calculating the total p.d. you just need to use the p.d. value once.

Series and Parallel Circuit

Exam Style Question 6

- (a) A student is given three resistors of resistance 3.0Ω , 4.0Ω and 6.0Ω respectively.
- (i) Draw the arrangement, using all three resistors, which will give the largest resistance.
- (ii) Calculate the resistance of the arrangement you have drawn.
- (iii) Draw the arrangement, using all three resistors, which will give the smallest resistance.
- (iv) Calculate the resistance of the arrangement you have drawn.
- (b) The three resistors are now connected to a battery of emf 12 V and negligible internal resistance, as shown in Figure 1.

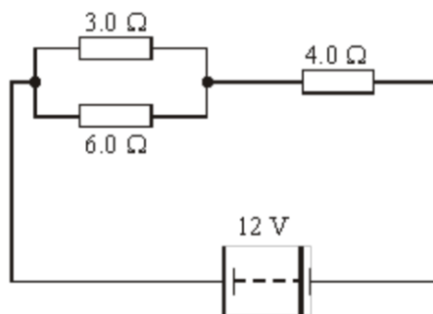

Figure 1

- (i) Calculate the total resistance in the circuit.
- (ii) Calculate the voltage across the 6.0Ω resistor.

Series and Parallel Circuit

Exam Style Question 6

- (a) (i) Draw the arrangement, using all three resistors, which will give the largest resistance.

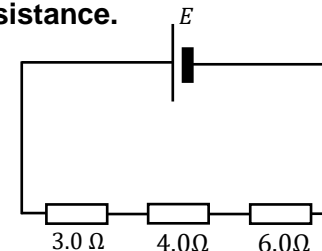

- (a) (ii) Calculate the resistance of the arrangement you have drawn.

$$R = 3.0 \Omega + 4.0 \Omega + 6.0 \Omega = 13 \Omega$$

- (a) (iii) Draw the arrangement, using all three resistors, which will give the smallest resistance.

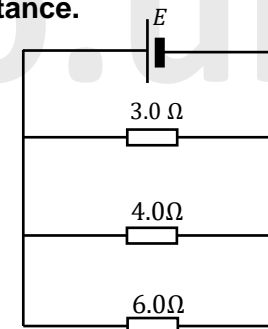

- (a) (iv) Calculate the resistance of the arrangement you have drawn.

$$\begin{aligned} \frac{1}{R_{TOTAL}} &= \frac{1}{R_1} + \frac{1}{R_2} + \frac{1}{R_3} = \frac{1}{3.0 \Omega} + \frac{1}{4.0 \Omega} + \frac{1}{6.0 \Omega} \\ \frac{1}{R_{total}} &= \frac{3}{4} \\ R_{total} &= 1.3 \Omega \end{aligned}$$

Series and Parallel Circuit

Exam Style Question 6

- (a) A student is given three resistors of resistance 3.0Ω , 4.0Ω and 6.0Ω respectively.
- (i) Draw the arrangement, using all three resistors, which will give the largest resistance.
- (ii) Calculate the resistance of the arrangement you have drawn.
- (iii) Draw the arrangement, using all three resistors, which will give the smallest resistance.
- (iv) Calculate the resistance of the arrangement you have drawn.
- (b) The three resistors are now connected to a battery of emf $12 V$ and negligible internal resistance, as shown in Figure 1.

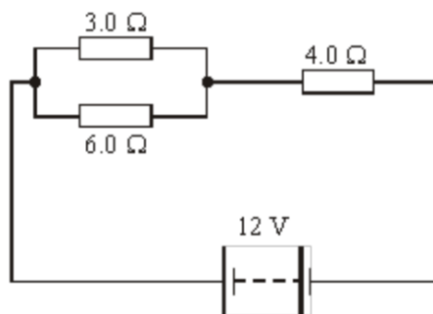

Figure 1

- (i) Calculate the total resistance in the circuit.
- (ii) Calculate the voltage across the 6.0Ω resistor.



Series and Parallel Circuit

Exam Style Question 6

- (b) (i) Calculate the total resistance in the circuit.

Calculate the total resistance in the two parallel resistors first:

$$\frac{1}{R} = \frac{1}{3 \Omega} + \frac{1}{6 \Omega}$$
$$\frac{1}{R} = \frac{1}{2}$$
$$R = 2 \Omega$$

Then add that resistance to the 4.0Ω in series to give:

$$R_{total} = 2 \Omega + 4 \Omega = 6 \Omega$$

- (b) (ii) Calculate the voltage across the 6.0Ω resistor.

Step 1: Find out the total current through the circuit which is:

$$V = IR$$
$$I = \frac{V}{R_{TOTAL}} = \frac{12 V}{6 \Omega} = 2 A$$

Step 2: We already know the total resistance of the two parallel resistors which is 2Ω and we also know the current entering to be $2 A$. Using $V = IR$ the voltage is:

$$V = 2 A \times 2 \Omega = 4 V$$

As the resistors are in parallel they both will have the same $4 V$ p.d. across it therefore the voltage across the 6.0Ω is $4 V$.

Please see '**3.5.1 Series and Parallel Circuit notes**' pack for revision notes.

For more revision notes, tutorials and worked examples please visit www.tutorpacks.co.uk.

tutorpacks.co.uk

